

DT SWISS

RATCHET HUBS (180, 240, 350)
TECHNICAL MANUAL

V2022.09

1. GENERAL	3
1.1 Validity.....	3
1.2 Safety	3
1.3 Target group.....	3
1.4 Layout.....	3
1.5 DT Swiss manual concept	3
1.6 General Maintenance Information	4
1.7 Environmental protection.....	4
1.8 Exclusion of liability.....	4
1.9 Warranty.....	4
2. MAINTENANCE OF THE REAR WHEEL HUB WITH RATCHET SYSTEM	5
2.1 Overview.....	5
2.2 Required tools.....	6
2.3 Required wearing parts and materials.....	7
2.4 Removing end caps, freewheel body and freewheel system	8
2.5 Checking the hub version.....	9
2.6 Dismounting the ring nut	9
2.7 Dismounting the ball bearing on the non drive side	10
2.8 Dismounting the ball bearing at the drive side	11
2.9 Cleaning and checking all parts	12
2.10 Mounting the ball bearing at the drive side.....	12
2.11 Mounting the ring nut and the shim	14
2.12 Mounting the hub seal.....	16
2.13 Mounting the ball bearing at the non drive side	17
2.14 Mounting the freewheel system.....	19
2.15 Putting on the freewheel body and the end caps	20
2.16 Check the functionality.....	21
3. TROUBLE SHOOTING.....	22

1. GENERAL

1.1 VALIDITY

This manual describes the component specified on the front page and the footer. This manual is valid for the design of the product as of 27.09.22. Deviations are possible and all items are subject to technical changes.

1.2 SAFETY

The safety instructions are classified as follows:



DANGER

...indicates a hazardous situation that, if not avoided, will result in death or serious injury.



CAUTION

... indicates a hazard with a medium level of risk which, if not avoided, may result in minor or moderate injury.



NOTE

... indicates a potentially hazardous situation that may result in damage to property.

1.3 TARGET GROUP

This manual is intended for the user of the component and dealers. This manual offers the experienced user the possibility to carry out minor service work himself. If you have any doubts about your own abilities, you should definitely contact an expert or a DT Swiss Service Center.

Any warranty claims will lapse if work is not carried out properly.

1.4 LAYOUT

The cover page and the footing provide information about the type of product and manual as well as the version of the manual. The DT Swiss contact details can be found on the back. A list of all DT Swiss service centers can be found at www.dtswiss.com.

This manual is intended for being printed as an A5 booklet. Only print this manual if electronic usage is not possible.

1.5 DT SWISS MANUAL CONCEPT

The DT Swiss manuals are split into the following types of manuals:

- User Manual: Information for the end user on how to install and use the component.
- Technical Manual: Detailed information for the end user and the dealer on how to maintain the component, spare parts and technical data.

1.6 GENERAL MAINTENANCE INFORMATION

Unless otherwise specified, moving parts, threads, O-rings and sealings must be greased before assembly.

CLEANING

For an optimal result of the maintenance work, every component that will be disassembled must be cleaned. Only use cleaners and degreasers which do not damage the components. Especially the cleaning of O-rings and sealings requires mild cleaners. Observe the instructions for use of the respective cleaner.

DT Swiss recommends the following cleaners:

- Motorex Rex
- Motorex Swissclean
- Motorex OPAL 2400, 3000 OPAL, OPAL 5000

Use soap water or similar mild cleaners for external cleaning.

TOOLS

To ensure a damage-free mounting and dismounting of the components, only use the tools which are mentioned in this manual. Special tools are indicated at the beginning of a chapter in the table "Required material".

The use of different tools is at the discretion of the user. If components are damaged by the usage of differing tools, the user is liable.

DT Swiss special tools are precision tools. Damage-free mounting and dismounting of the components can only be ensured if the tools are working properly and if the condition of the tools are perfect. Always keep the tools in their original packaging or adequate devices to prevent damage.

1.7 ENVIRONMENTAL PROTECTION

The statutory regulations shall apply. Whenever possible, avoid creating waste. Waste, especially carbon, lubricants, cleaners and any other fluids must be disposed in an environmentally compatible manner. Only print this manual if electronic usage is not possible.

1.8 EXCLUSION OF LIABILITY

The activities listed in this manual may only be carried out by persons with sufficient specialist knowledge. The user is liable for any damage or consequential damage caused by wrongly maintained or installed components. If you have doubts, please contact an expert or your region's DT Swiss pro level service center.

1.9 WARRANTY

Warranty conditions, see www.dtswiss.com

2. MAINTENANCE OF THE REAR WHEEL HUB WITH RATCHET SYSTEM

2.1 OVERVIEW

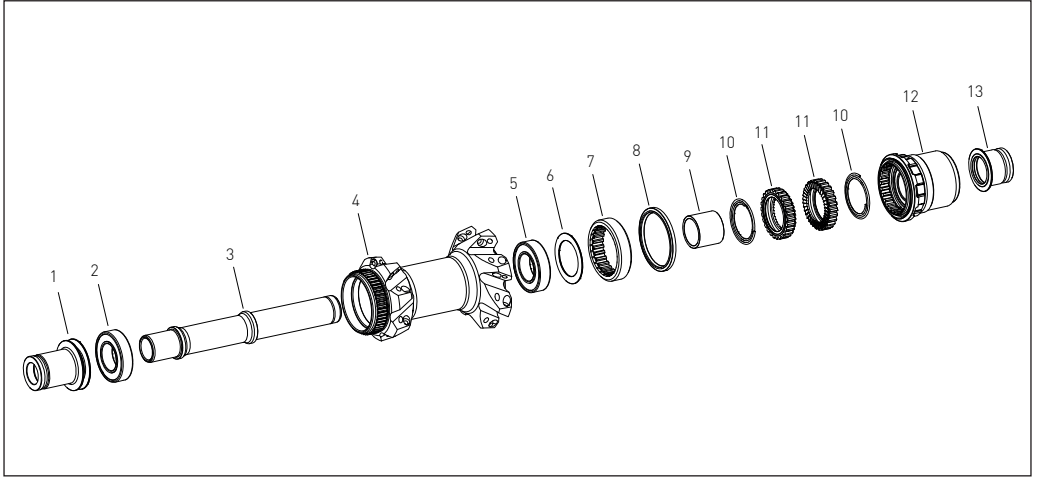

1	end cap non drive side	6	shim	11	ratchet
2	ball bearing non drive side	7	ring nut	12	freewheel body
3	axle	8	hub seal	13	end cap drive side
4	hub shell	9	spacer		
5	ball bearing drive side	10	spring		

ATTENTION: 180 and 240 hubs are equipped with the Ratchet EXP system starting with the 2020 model year. This manual only describes hubs with the Ratchet System.

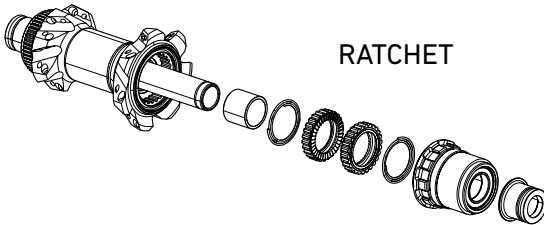

RATCHET

The Ratchet System is essentially characterized by two loose ratchets.

All maintenance activities for this hub can be found in this manual.

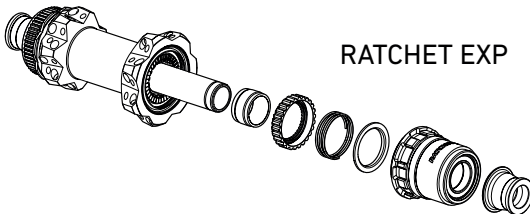



RATCHET EXP

The Ratchet EXP system is essentially characterized by one loose and one threaded ratchet.

All maintenance activities for this hub can be found in the technical manual at www.dtswiss.com.

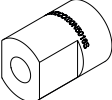
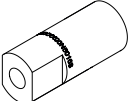
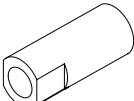
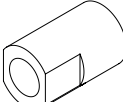
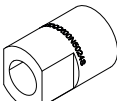
2.2 REQUIRED TOOLS

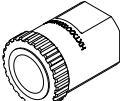
Tools	Specification	Quantity	Article number
installation cylinder $\varnothing 10 / 26$ mm x 35 mm		1*	HXTXXX00N5016S
installation cylinder $\varnothing 10 / 26$ mm x 60 mm		1*	HXTXXX00N5017S
installation cylinder $\varnothing 15 / 24$ x 60 mm		1*	HXTXXX00N5025S
installation cylinder $\varnothing 15 / 26$ x 40 mm		1*	HXTXXX00N5314S
installation cylinder $\varnothing 15 / 28$ x 35 mm		1*	HXTXXX00N5024S
installation cylinder $\varnothing 17 / 26$ mm x 35 mm		1*	HXTXXX00N5068S
installation tool for hub seal		1	HXTXXX00N1000S
tool for ring nut		1	HXTXXX00N5027S

*Depending on the hub model, one or two of the specified installation cylinders are required.

2.3 REQUIRED WEARING PARTS AND MATERIALS

Wearing parts / Materials	Specification	Quantity	Article number
DT Swiss universal grease		20 g	HXTXXX00NMG20S
DT Swiss special grease		20 g	HXT10032508S
ring nut aluminum M34 x 1 mm suitable for hubs with ball bearing Ø28 mm on the drive side		1	HCDXXX00S1110S
ring nut steel M34 x 1 mm suitable for hubs with ball bearing Ø28 mm on the drive side		1	HXDXXX00N1131S
shim Ø28 / 20 x 0,5 mm suitable for ring nut HCDXXX00S1110S and HXDXXX00N1131S		1	HCDXXX00S1083S
ring nut aluminum M34 x 1 mm suitable for hubs with ball bearing Ø26 mm on the drive side		1	HCDXXX00S3743S
shim Ø26 / 20 x 0,5 mm suitable for ring nut HCDXXX00S3743S		1	HCDXXX00S3895S
hub seal		1	HSOXXX00N1031S
spacer aluminum 15.4 mm		1	HCDXXX00S1077S

Due to the large variety of ball bearings, freewheel bodies and ratchets, these cannot be listed here. Contact your dealer for the appropriate spare part.

2.4 REMOVING END CAPS, FREEWHEEL BODY AND FREEWHEEL SYSTEM

1. Pull off both end caps by hand.

If the end caps cannot be pulled off by hand, clamp the end caps carefully into a vise with ground clamping jaws and pull the hub / wheel upwards.



2. Pull the freewheel body off the hub.



3. Remove springs, ratchets and spacer from the hub.



2.5 CHECKING THE HUB VERSION

On individual hubs from model year 2015 onwards, ball bearings with a smaller outside diameter (\varnothing 26 mm) are installed on the drive side. This allows the ball bearing to be replaced without removing the ring nut. For all other hubs, the ring nut must be removed in order to change the ball bearing on the drive side. Before further disassembly steps check which hub version is available.

1. Check whether the shim under the ring nut can be removed.
 - If the shim cannot be removed, the ring nut on the drive side must be removed to change the ball bearing.
 - If the shim can be removed, it is not necessary to remove the ring nut on the drive side to change the ball bearing.



2.6 DISMOUNTING THE RING NUT

Due to the torque acting on the ring nut during pedaling, the ring tightens while riding. Therefore, loosening the ring nut requires a high force. The ring nut can only be loosened, when the wheel is complete as the lever is much larger.

1. Clamp the ring nut tool in the high position in the vise.
2. Push the hub onto the tool with the drive side first.
3. Loosen the ring nut by turning the wheel counterclockwise.
 - The hub seal in front of the ring nut is released from its press fit by unscrewing the ring nut.
4. Remove the hub from the tool.
5. Remove the ring nut, hub seal and shim.



2.7 DISMOUNTING THE BALL BEARING ON THE NON DRIVE SIDE

1. Tap out the ball bearing on the non drive side with slight hammer strokes onto the axle.



2. Remove the ball bearing from the axle.



2.8 DISMOUNTING THE BALL BEARING AT THE DRIVE SIDE

1. Insert the short side of the axle through the second ball bearing on the drive side.
2. Put the installation cylinder onto the axle.
 - By using the installation cylinder, the ball bearing cannot tilt during disassembly. Damage to the bearing seat is not possible.
3. Tap out the ball bearing with slight hammer strokes on the axle.
4. Remove the installation cylinder from the hub.
5. Remove the ball bearing from the axle.



2.9 CLEANING AND CHECKING ALL PARTS

1. Thoroughly clean all parts of the hub. The existing grease must be completely removed from the hub body and from the ratchets.
2. Check the ratchets for wear.

The wear of the ratchets usually starts at the outer circumference and shows itself by strongly flattened edges with uneven wear.

In case of heavy wear, the ratchets must be changed immediately.



3. Check the freewheel body for damages.
→ Grooves from the cassette are no damages. These are normal signs of usage.
4. Remove bad notches on the freewheel body using a file.
5. Clean the freewheel body. Metal chips and metal particles must be removed completely.

2.10 MOUNTING THE BALL BEARING AT THE DRIVE SIDE

On some hubs from model year 2015 onwards, ball bearings with a smaller outside diameter (\varnothing 26 mm) are installed on the drive side. This allows the ball bearing to be replaced without removing the ring nut.

Always mount the ball bearing on the drive side first.

If the ring nut has been removed:

1. Grease the bearing seats and the thread of the ring nut with universal grease.

If the ring nut has not been removed:

1. Grease the bearing seat under the ring nut with universal grease.
→ No grease must get onto the toothing of the ring nut!



- Put the installation cylinder into the vise.
- Insert the long side of the axle into the installation cylinder.
- Place the hub shell onto the tool and the axle.
- Push a new bearing on the hub shell with the colored side facing outwards.



- Put the installation cylinder onto the bearing.
- Tap in the ball bearing carefully with slight hammer strokes.
- Remove the installation cylinder and the axle from the hub.



- Remove the wheel from the installation cylinder in the vise and tap the bearing with a installation cylinder and the axle as a guide until stop (approx. 0.2 mm).



2.11 MOUNTING THE RING NUT AND THE SHIM

All hubs model year <2015:

1. Clamp the tool for ring nut in the deep position in the vise.
2. Slide the ring nut onto the tool with the recess facing upwards.
3. Insert the shim in the recess of the ring nut.



Hubs with ball bearings with smaller outer diameter (Ø 26 mm) on the drive side ("Checking the hub version" on page 9):

1. Clamp the tool for ring nut in the deep position in the vise.
2. Slide the ring nut onto the tool.
3. Insert the axle, long side first, from the non drive side through the ball bearing on the drive side.

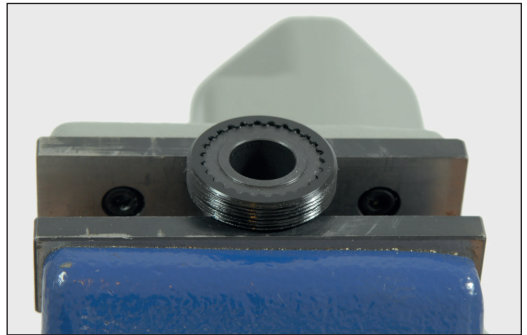

4. Grease the ball bearings on the drive side with universal grease.
5. Place the hub / wheel with the axle on the tool.
6. Put the installation cylinder onto the axle.
→ By using the installation cylinder, the threaded ratchet cannot tilt when screwed in.
7. Screw in the ring nut approx. 2 turns.



8. Unclamp the ring nut tool, turn it 90° and clamp it back into the vise in the high position.
9. Place the hub / wheel with the ring nut back on the tool and tighten the ring nut by hand as tight as possible.



Hubs with smaller ball bearing (Ø 26 mm) on the drive side ("Checking the hub version" on page 9):

10. Slide the shim onto the ball bearing on the drive side.



2.12 MOUNTING THE HUB SEAL

The hub seal only needs to be replaced if the ring nut has been removed.

1. Put the installation cylinder into the vise.
2. Insert the axle into the installation cylinder with the short side facing down.
3. Put the non drive side of the hub / wheel with the axle onto the installation cylinder.
4. Place the hub seal on the installation tool.
5. Put the installation tool with the hub seal onto the axle.
6. Push on the second installation cylinder and drive in the hub seal with slight hammer strokes.



2.13 MOUNTING THE BALL BEARING AT THE NON DRIVE SIDE

1. Clamp the tool for the ring nut in the vise.
2. Push the hub / wheel with the drive side onto the tool for the ring nut.
3. Push the axle with the long side first into the ball bearing on the drive side.



4. Grease the bearing seats with universal grease.



5. Put on a new bearing on the non drive side with the colored side facing outwards.



6. Put the installation cylinder onto the bearing.
7. Tap in the ball bearing carefully with slight hammer strokes.



8. Check the ball bearings.
 - The hub must turn smoothly.
 - The hub must not have axial play.
9. If necessary, drive in the bearing on the non drive side or loosen the bearing.
10. Repeat previous steps until the hub is turning smoothly.

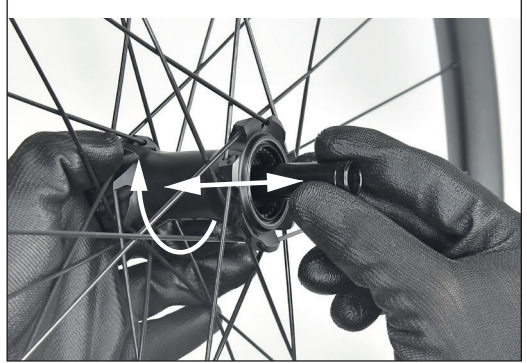

2.14 MOUNTING THE FREEWHEEL SYSTEM



DANGER

RISK OF INJURY DUE TO LIMITED FREEWHEEL FUNCTION DUE TO INCORRECT LUBRICATION!

If too much grease is applied on the ratchets, the actuation of the ratchets may not work. The ratchets may slip during pedaling.

- Only apply a thin, even layer of grease.
- Only use the red DT Swiss special grease.

1. Apply DT Swiss special grease evenly to the outer and the inner tothing of the ratchets using a fine brush.
→ For an optimal functionality of the freewheel system, a thin layer of grease is sufficient.



2. Grease the teeth of the freewheel body and the ring nut with DT Swiss special grease.



3. Attach the spacer and the first spring.
→ The spring must rest on the hub with its large diameter.



4. Attach both ratchets and the second spring.
5. The spring must rest with its small diameter on the ratchet.



2.15 PUTTING ON THE FREEWHEEL BODY AND THE END CAPS

1. Put the freewheel body onto the hub.
2. Check if the freewheel body can be turned and if the ratchets are engaging.



3. Grease both bearings and the inner side of both end caps.



4. Put on the left and the right end cap.
 - The shorter end cap must be placed on the drive side.
5. Push in end caps by hand.



2.16 CHECK THE FUNCTIONALITY

1. Turn the freewheel body in both directions.
 - The freewheel body can be turned counterclockwise easily.
 - The ratchets engage audibly and perceptibly.
 - The freewheel body cannot be turned clockwise.
2. Check the tightness of the end caps.
 - The end caps are firmly seated on the axle and are fully pushed on.

3. TROUBLE SHOOTING

Issue	Reason	Solution
Freewheel jammed / blocked	Spacer was forgotten during assembly.	Check correct assembly, see "2.14 Mounting the freewheel system", page 19.
	Spacer was compressed by overtightening the thru axle.	Measure the length of the spacer. If the spacer is shorter than 15.4 mm, it must be replaced.
	The ring nut has been fitted the wrong way round or has not been screwed in far enough.	Check the correct assembly of the ring nut.
	The hub seal was mounted upside down.	Check the alignment of the hub seal.
	The shim was not mounted correctly.	The shim must be centered and flush in the recess in the ring nut.
	An end cap that does not fit has been mounted.	Shimano end caps on a SRAM XD freewheel can cause jamming.
	Defects on the hub body, on the freewheel or on one of the end caps.	Check all parts for defects and replace parts as necessary.
Freewheel does not engage / slips	One or both ratchets are mounted upside down.	Check correct assembly, see "2.1 Overview", page 5.
	Too much or wrong grease on the ratchets.	Clean and grease ratchets, see "2.14 Mounting the freewheel system", page 19.
	Ratchets are worn.	Replace ratchets.
	One or both springs were forgotten during assembly.	Check correct assembly, see "2.1 Overview", page 5.
Hub has axial play	Ball bearings were not mounted correctly.	Check correct assembly, see "2.1 Overview", page 5.
	Ball bearings are worn out.	Replace ball bearings.
Hub rotates stiffly	Ball bearings are worn out.	Replace ball bearings.
	Ball bearing non drive side too tight.	Check correct assembly, see "2.1 Overview", page 5.
	Mounting sequence of the ball bearings not observed.	
Hub makes noise	Ball bearings are worn out.	Replace ball bearings.
Notches from the cassette on the freewheel body.	The steel cassette works itself into the alloy web of the freewheel body.	Remove bad notches on the freewheel body using a file.
Freewheel body rotates with difficulty.	Ball bearings in the freewheel body are worn out.	Replace freewheel body.

Issue	Reason	Solution
Freewheel is too noisy / too quiet.		The perception of the freewheel sound is very subjective. While some riders prefer a loud freewheel sound, other riders want a quiet freewheel. In principle, the freewheeling sound can be influenced by the amount of grease between the ratchets. Less grease increases the freewheeling sound, but at the same time leads to higher wear.

DT SWISS AG

Längfeldweg 101
CH - 2504 Biel/Bienne
service.ch@dtswiss.com

DT SWISS, INC.

2493 Industrial Blvd.
USA - Grand Junction, CO 81505
techusa@dtswiss.com

DT SWISS (FRANCE) S.A.S.

Parc d'Activites de la Sarrée
Route de Gourdon
F - 06620 Le Bar sur Loup
service.fr@dtswiss.com

DT SWISS ASIA LTD.

No.5, Jingke 5th Rd., Nantun District
Taichung City 408
Taiwan (R.O.C.)
service.tw@dtswiss.com

DT SWISS DEUTSCHLAND GmbH

Albert-Einstein-Strasse 3
59302 Oelde
Germany
service.de@dtswiss.com

DT SWISS POLSKA Sp. z o.o.

ul. Towarowa 36
PL-64-600 Oborniki
Poland
service.pl@dtswiss.com

Subject to technical alterations, errors and misprints excepted.

All rights reserved.

© by DT SWISS AG

www.dtswiss.com

WXD1000000896S